

Alfa Romeo 8C

BODY SHELL

Official Licensed Product

NO.48091

killerbody™

1/7 RC PLANNING INSTRUCTION SHEET

This body can be used with 1/7 electronic car (Long Wheelbase: 402mm Width: 284mm)

Fit for the Traxxas XO-1 Cn-Road Car

Before beginning assembly, please read these instructions thoroughly!

● Symbols used throughout the instruction manual, comprise:



Cut off shaded portion.



5mm
Drill holes with
the specified diameter.



Pay close attention here!



Must be purchased
separately.



Assemble left and right sides
the same way.



● Before Assembly

Decoration Body

- ▶ In the case of a decoration body, please assemble it according to the contents showed.

When making the window transparent:

- ▶ If you want to make the window transparent with a non decoration body, please assemble it according to the contents showed.

Non Decoration Body

- ▶ In the case of non decoration body, please assemble it according to the contents showed.

When loading LED lights

- ▶ If you want to load LED lights with a non decoration body, please assemble it according to the contents showed.

PARTS

BODY	-----	X1
PLASTIC PARTS	-----	X1
ELECTROPLATED PARTS	-----	X1
WINDOW MASKS	-----	X1

PARTS BAG

	LED STOPPER	-----	X2
	Clip	-----	X10
	O-Ring	-----	X5
	TAPPING SCREW	-----	X12
	DOUBLE-SIDED TAPE	-----	X1
	ALUMINUM TAPE	-----	X1

ELECTROPLATED PARTS

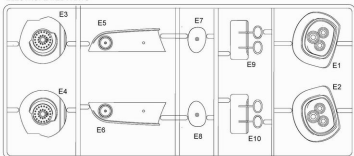

PLASTIC PARTS

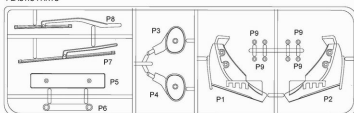

1 Body Shell

When making the window transparent:

Non Decoration Body

When loading LED lights

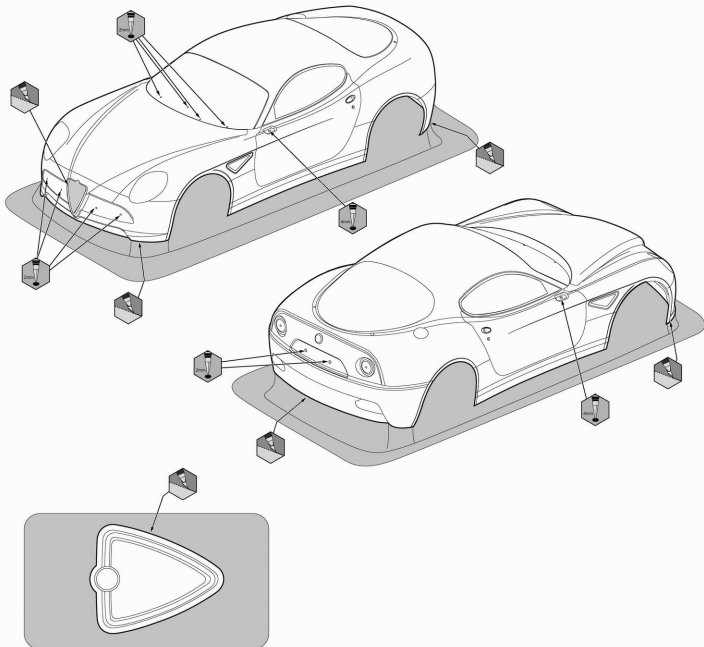

2 Painting

Non Decoration Body
When loading LED lights



- 1 Before painting, use a neutral detergent to remove any oil residues and dirt.

When making the window transparent:

When making the window transparent:

When loading LED lights

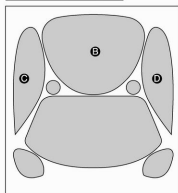

2 Mask the windows from the inside.

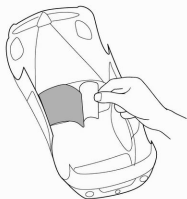

2 Mask the lights from the inside.

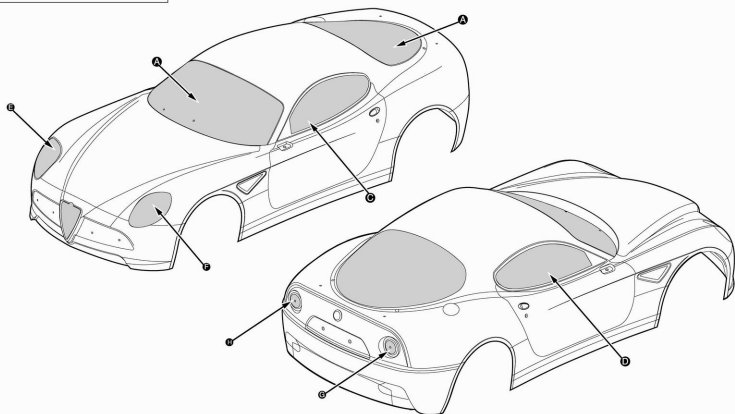
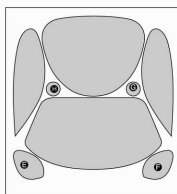

3 Paint the body shell from the inside.

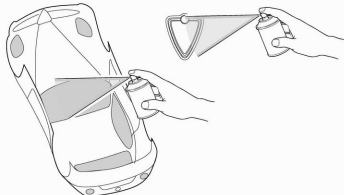

4 After painting, remove the protective film from the body shell.

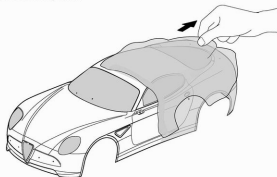

3 Decal

Non Decoration Body

When making the window transparent

When loading LED lights

► The decal numbers between brackets are only for the opposite side.

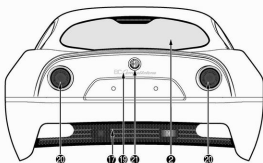
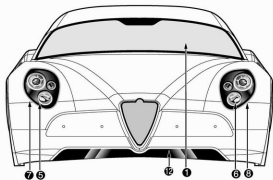

< Decal >

When making the window transparent

When reproducing the light by decal

- 
 ► 1 2 3 4 Cut the translucent (smoked color) part.
 ► Change the decal according to the following contents.
6 → 7
8 → 9

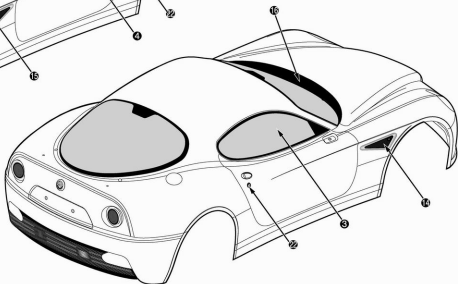
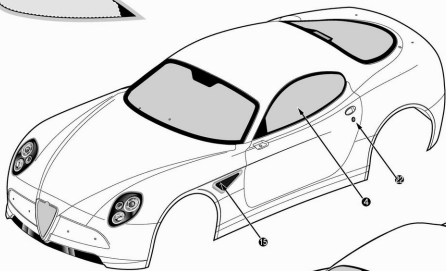

4 Plastic Parts

Decoration Body

Non Decoration Body

When making the window transparent.

When loading LED lights

Clip 2



O-Ring 2

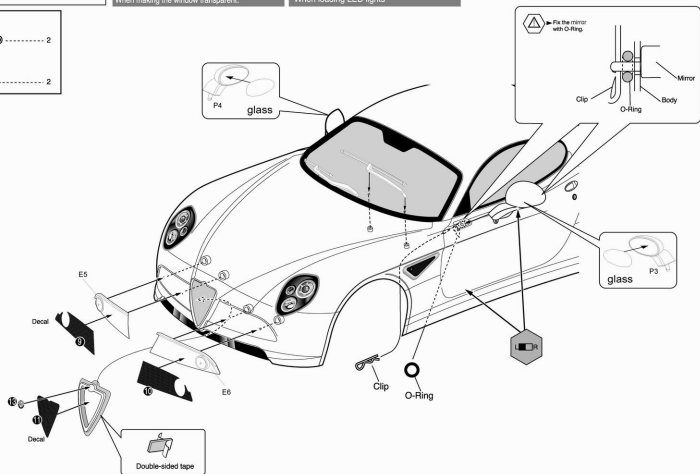

5 Plastic Parts

Decoration Body

Non Decoration Body

When making the window transparent

When loading LED lights

2 x 7mm FH TP Screw 2

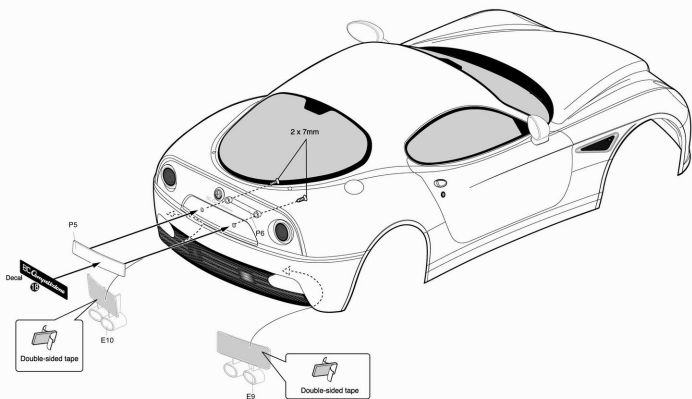

6 Plastic Parts

When loading LED lights

LED STOPPER

2 x 7mm FH TP Screw

2 x 7mm FH TP Screw

< Front >



- ▶ Please tape the wiring, etc. on the body using the attached aluminum tape.
- ▶ Please put the attached aluminum tape on the top and bottom of the headlight and the taillights.

2 x 7mm

< Rear >

2x7mm

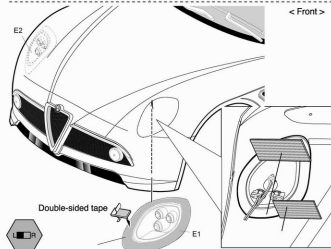

< Front >

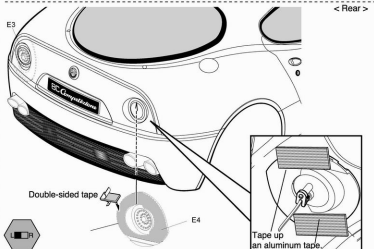

< Rear >

7 Body

Decoration Body

When making the window transparent:

Non Decoration Body

When loading LED lights



- ▶ For safety reasons, always fit the body shell when running your car.

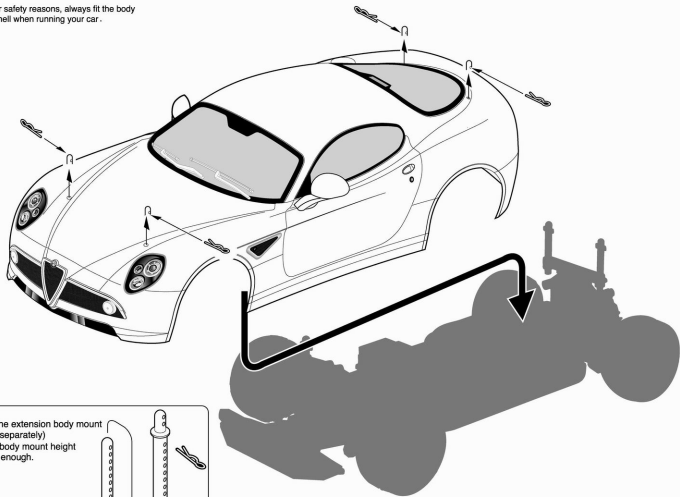

- ▶ Use the extension body mount (sold separately) if the body mount height is not enough.

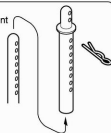

8 Refitting the rear part

Decoration Body

Non Decoration Body

When making the window transparent:

When loading LED lights

-  For safety reasons, always fit the body shell when running your car.

The rear part needs to be refitted if you assemble the body on the Traxxas XO-1 On-Road Car.

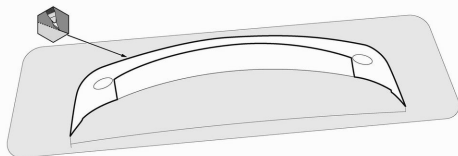

- 1 Before painting, use a neutral detergent to remove any oil residues and dirt.



- 2 Paint the body shell from the inside.

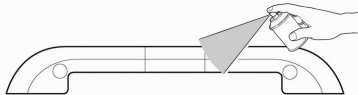

- 2 After painting, remove the protective film from the body shell.

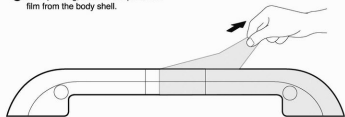

1. Cut the bottom part at the rear

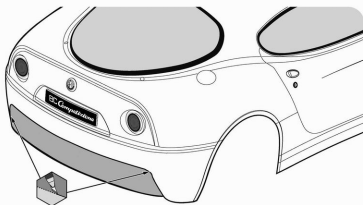

2. Assemble the accessories

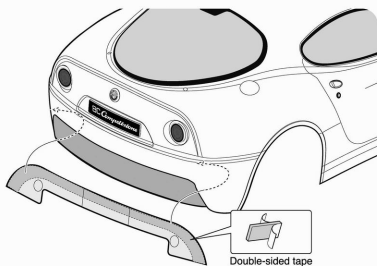

- The effect after assembled on the chassis



8 Front Spoiler

Decoration Body

When making the window transparent.

Non Decoration Body

When loading LED lights



► For safety reasons, always fit the body shell when running your car.

4X10mm F/H TP Screw

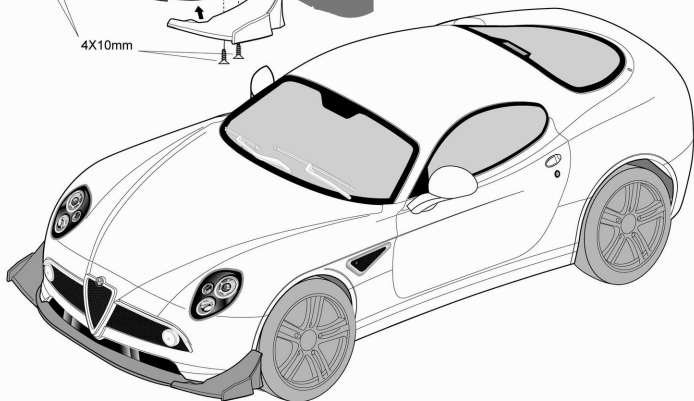
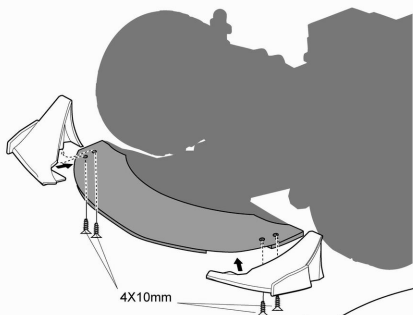

Option Parts & Accessory

No.	Part Names	No.	Part Names
48091	Alfa Romeo RC Clear Body Used with 1/7 RC electric car	48088	Injection Accessories (Alfa Romeo RC) Used with 1/7 RC electric car
48092	Alfa Romeo RC Finished Body Dark metallic red (Printed) Used with 1/7 RC electric car	48073	Rear Wing (injection molded) Used with 1/7 RC electric car
48093	Alfa Romeo RC Finished Body Dark metallic blue (Printed) Used with 1/7 RC electric car	48113	Rear Wing (hexan molded) Clear Used with 1/7 RC electric car
48094	Alfa Romeo RC Finished Body Silver (Printed) Used with 1/7 RC electric car	48114	Rear Wing (hexan molded) Carbon fiber pattern Used with 1/7 RC electric car
48095	Alfa Romeo RC Finished Body Silver-grey (Printed) Used with 1/7 RC electric car	48115	Rear Wing Mount (CNC Aluminum) Used with 1/7 RC electric car
48097	Electroplated Light Bucket (Alfa Romeo RC) Used with 1/7 RC electric car	48116	Rear Wing Mount (CNC Aluminum) Used with 1/7 RC electric car